

Wall mounted receptacle with TwinCONTACT - Part no. 1880

Std. Pack. 10 Qty.

- screwless spring terminals
- suitable for through wiring
- with 4 external fixing points
- one cable entry at top and one blind entry (can be cut out) at bottom
- receptacles are designed for adding an auxiliary contact switch

Protection type	IP 67
Ampere	32A
Poles	4p
Voltage	230V
Hertz	50-60 Hz
Earth position	9h
Contact	standard
Connection technology	Screwless - TwinCONTACT
Shutter	

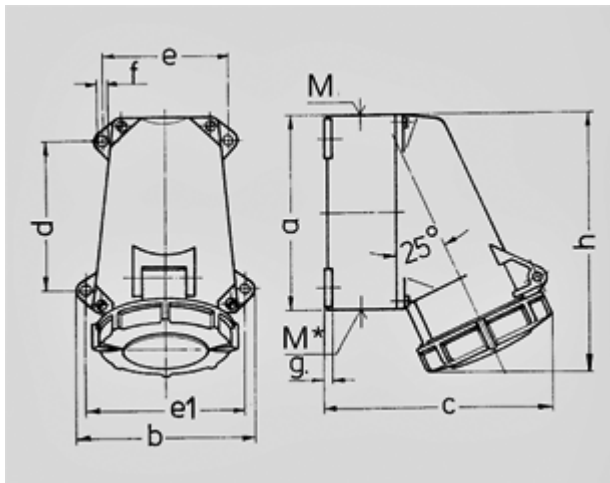

Drawing	Amp.	16			32		
		Poles			Poles		
1 MB 219		3	4	5	3	4	5
Dim. in mm	a	95	95	95	120	120	120
	b	102	102	102	112	112	112
	c	115	124	129	143	143	150
	d	64,2	64,2	64,2	90,2	90,2	90,2
	e	77,5	77,5	77,5	79	79	79
	e1	88	88	88	98,5	98,5	98,5
	f	5,5	5,5	5,5	5,5	5,5	5,5
	g	5	5	5	5	5	5
	h	128	128	132	160	160	160
	M	25	25	25	32	32	32
	M*	25	25	25	M32 (blind)		
		(blind) to be cut out			to be cut out		
Max. cable diam. (mm)		15	18	18	25	25	25
Terminal for cond. cross section (mm ²) min.-max.		1,5	1,5	1,5	2,5	2,5	2,5
		-4	-4	-4	-10	-10	-10