

MASTERColour CDM
MASTERColour CDM-T

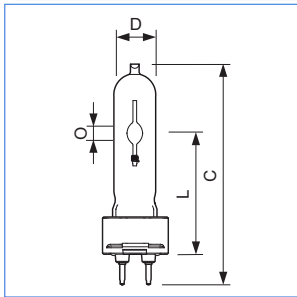

Dim. nr.	C max.	D max.	L nom.	O nom.
1	103	20	56	4



Produkt beskrivelse

- Familie av en-soklede, kompakte, høyeffektive utladningslamper med stabil farge gjennom hele levetiden med krisp, utstrålende lys

Produkt fordeler

- Stabilt fargetemperatur gjennom hele levetiden
- Høy lampe-effektivitet resulterer i lave driftskostnader
- Lang levetid sammenlignet med gløde- og halogenlamper

- Relativt liten varme-avgivelse øker komforten for kunder og betjening
- Alle typer har UV-blokkering for å redusere risikoen for bleking

Produkt egenskaper

- Krisp hvitt lys
- Suveren fargegjengivelse
- Gjør mulig kompakt, liten, armaturdesign som gir høy stråleintensitet

Bruksområder

- Butikker og butikkvinduer, kontorer og offentlige bygninger
- Dekorativt utendørs: flombelysning og gågater

Sikkerhet

- Bruk bare i lukkede armaturer også ved testing. (IEC 61167), IEC 62035, IEC 60598)
- Kontrollforkoblingen må inkludere sikkerhet mot utfall mot slutten av lyskildens levetid (IEC 61167, IEC 62035)
- Armaturet skal kunne tåle og stoppe varme deler fra lyskilden, hvis lyskilden går istykker
- Både elektromagnetisk og elektroniske forkoblinger kan benyttes med unntak av 35 W/942 og 20 W som kun skal benyttes med elektroniske forkoblinger

Type	Effekt/ Fargekode	Sokkel	Paknings-type	Paknings-utførelse	Lys- ytelse EM (lm)	Lys- ytelse EL (lm)	Lampens lysutbytte EL (lm/W)	Brenn- stilling	Dim. nr.	Photo letter	EOC
MASTERColour CDM-T	20W/830	G12	ICT	12		1 800	90	Universell	A+	1	A 872790087156200
MASTERColour CDM-T	35W/830	G12	ICT	12	3 000	3 150	81	Universell	A+	2	B 871150019697215
MASTERColour CDM-T	35W/842	G12	ICT	12		3 100	79	Universell	A+	2	B 871150021126215
MASTERColour CDM-T	70W/830	G12	ICT	12	6 400	6 500	89	Universell	A+	3	C 871150019699615
MASTERColour CDM-T	70W/942	G12	ICT	12	6 300	6 300	86	Universell	A+	4	C 871150019927015
MASTERColour CDM-T	150W/830	G12	ICT	12	13 200	13 600	91	Universell	A+	5	D 871150019780115
MASTERColour CDM-T	150W/942	G12	ICT	12	12 000	12 700	85	Universell	A+	6	D 871150020005115
MASTERColour CDM-T	250W/830	G12	ICT	12	27 540			Universell	A+	7	E 871150020801915
MASTERColour CDM-T	250W/942	G12	ICT	12	26 000			Universell	A+	7	E 871150021112515

5-20H071

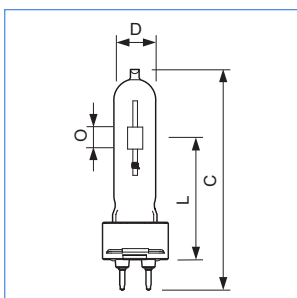

Dim. nr.	C max.	D max.	L nom.	O nom.
2	103	20	56	5
3	103	20	56	7
4	103	20	56	6
5	110	20	56	9
6	110	20	56	8

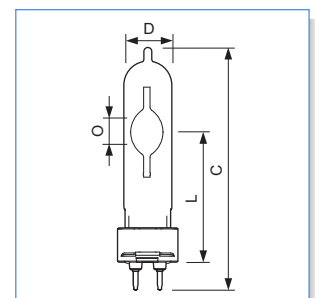

Dim. nr.	C max.	D max.	L nom.	O nom.
7	135	25	72,5	12,3

MASTERColour CDM
MASTERColour CDM-T
Additional technical data

Produktnavn	Fargetempe- ratur	Fargegjengi- velses indeks (CRI)	Energy consumption kWh/1000h	Sokkeltem- peratur	Kolbetempe- ratur	Lampespen- ning	Lampe strøm EL	Lampe strøm i startperiode
	(K)	(R _a)	(kWh)	(°C [max.])	(°C [max.])	(V)	(A)	(A [max.])
MASTERColour CDM-T 20W/830 G12	3000	84	22	-	250	94	0.215	0.50
MASTERColour CDM-T 35W/830 G12	3000	81	41	280	500	88	0.470	0.80
MASTERColour CDM-T 35W/842 G12	4200	84	41	280	500	85	0.460	0.72
MASTERColour CDM-T 70W/830 G12	3000	84	80	280	500	88	0.870	1.40
MASTERColour CDM-T 70W/942 G12	4200	92	80	280	500	88	0.870	1.40
MASTERColour CDM-T 150W/830 G12	3000	88	165	280	650	96	1.620	2.50
MASTERColour CDM-T 150W/942 G12	4200	96	165	280	650	90	1.700	2.50
MASTERColour CDM-T 250W/830 G12	3000	85	273	280	700	95	-	6.00
MASTERColour CDM-T 250W/942 G12	4200	91	271	280	700	93	-	6.00

Produktnavn	Dimbar	Systemeffekt EL	Systemeffekt EM	Re-start tid[min]	Oppstartstid 90%	Lampe strøm EM
		(W)	(W)	(min. [max.])	(min. [max.])	(A)
MASTERColour CDM-T 20W/830 G12	Nei	23.5	-	15	3	-
MASTERColour CDM-T 35W/830 G12	Nei	44.0	47	15	3	0.53
MASTERColour CDM-T 35W/842 G12	Nei	44.0	-	15	3	-
MASTERColour CDM-T 70W/830 G12	Nei	83.0	88	15	3	0.98
MASTERColour CDM-T 70W/942 G12	Nei	80.0	88	15	3	0.98
MASTERColour CDM-T 150W/830 G12	Nei	167.0	165	15	3	1.80
MASTERColour CDM-T 150W/942 G12	Nei	167.0	165	15	3	1.90
MASTERColour CDM-T 250W/830 G12	Nei	271.0	271	15	3	2.99
MASTERColour CDM-T 250W/942 G12	Nei	271.0	271	15	3	3.04

2nd additional technical data

Produktnavn	Levetid til 5% utfall EL	Life to 10% failures EL	Levetid til 20% utfall EL	Levetid til 50% utfall EL
	(h)	(h)	(h)	(h)
MASTERColour CDM-T 20W/830 G12	9000	10000	12000	15000
MASTERColour CDM-T 35W/830 G12	8000	9000	10000	12000
MASTERColour CDM-T 35W/842 G12	8000	9000	10000	12000
MASTERColour CDM-T 70W/830 G12	9000	10000	11000	12000
MASTERColour CDM-T 70W/942 G12	9000	10000	11000	12000
MASTERColour CDM-T 150W/830 G12	9000	10000	11000	12000
MASTERColour CDM-T 150W/942 G12	9000	10000	11000	12000
MASTERColour CDM-T 250W/830 G12	3500	4500	5500	8000
MASTERColour CDM-T 250W/942 G12	3500	4500	5500	8000

Produktnavn	Opprettholdt lysutb.EL	Lumen Maintenance EL	Lysytelse EL	Design Mean Lumens EL	Design Mean Lumens EM
	10000t	12000h	(lm)	(lm)	(lm)
	(%)	(%)			
MASTERColour CDM-T 20W/830 G12	78	77	1800	1400	-
MASTERColour CDM-T 35W/830 G12	50	-	3150	2250	2000
MASTERColour CDM-T 35W/842 G12	70	-	3100	-	-
MASTERColour CDM-T 70W/830 G12	70	-	6500	5250	4400
MASTERColour CDM-T 70W/942 G12	65	-	6300	4900	3900
MASTERColour CDM-T 150W/830 G12	60	-	13600	9600	8900
MASTERColour CDM-T 150W/942 G12	70	-	12700	10800	9900
MASTERColour CDM-T 250W/830 G12	-	-	-	-	-
MASTERColour CDM-T 250W/942 G12	-	-	-	-	-

3rd additional technical data

Produktnavn	Lamp Wattage EL 25°C, Nominal	Lamp Wattage EM 25°C, Nominal
	(W)	(W)
MASTERColour CDM-T 20W/830 G12	20	-
MASTERColour CDM-T 35W/830 G12	35	35
MASTERColour CDM-T 35W/842 G12	35	-
MASTERColour CDM-T 70W/830 G12	70	70
MASTERColour CDM-T 70W/942 G12	70	70
MASTERColour CDM-T 150W/830 G12	150	150
MASTERColour CDM-T 150W/942 G12	150	150
MASTERColour CDM-T 250W/830 G12	-	250
MASTERColour CDM-T 250W/942 G12	-	250

MASTERColour CDM

MASTERColour CDM-T

Lagerdata

Produktnavn	El.nr.	Pakningstype	Beskrivelse pakningstype	Antall i kart.	Pakningsutførelse
MASTERColour CDM-T 20W/830 G12	3858343	ICT	I Lamp in a Folding Carton	12	12
MASTERColour CDM-T 35W/830 G12	3858240	ICT	I Lamp in a Folding Carton	12	12
MASTERColour CDM-T 35W/842 G12	3858212	ICT	I Lamp in a Folding Carton	12	12
MASTERColour CDM-T 70W/830 G12	3858241	ICT	I Lamp in a Folding Carton	12	12
MASTERColour CDM-T 70W/942 G12	3858251	ICT	I Lamp in a Folding Carton	12	12
MASTERColour CDM-T 150W/830 G12	3858242	ICT	I Lamp in a Folding Carton	12	12
MASTERColour CDM-T 150W/942 G12	3858252	ICT	I Lamp in a Folding Carton	12	12
MASTERColour CDM-T 250W/830 G12	3858211	ICT	I Lamp in a Folding Carton	12	12
MASTERColour CDM-T 250W/942 G12	3858214	ICT	I Lamp in a Folding Carton	12	12

Produktnavn	Antall per pakning	Pakningslengde (mm)	Pakningsbredde (mm)	Pakningshøyde (mm)	Gross weight per piece (g)	Net weight per piece (g)
MASTERColour CDM-T 20W/830 G12	1	149	131	136	40	27
MASTERColour CDM-T 35W/830 G12	1	149	131	136	39	27
MASTERColour CDM-T 35W/842 G12	1	149	131	136	40	28
MASTERColour CDM-T 70W/830 G12	1	149	131	136	41	29
MASTERColour CDM-T 70W/942 G12	1	149	131	136	42	29
MASTERColour CDM-T 150W/830 G12	1	149	131	136	45	33
MASTERColour CDM-T 150W/942 G12	1	149	131	136	47	33
MASTERColour CDM-T 250W/830 G12	1	176	161	177	60	39
MASTERColour CDM-T 250W/942 G12	1	176	161	177	60	39

Ytelses diagrammer

MASTERColour CDM-T /830

Lysytelse under oppstart

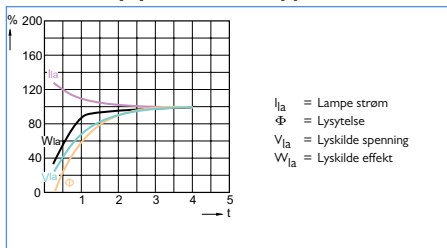

Lysytelse ved spenningsvariasjoner

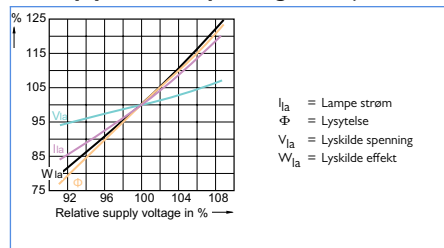

MASTERColour CDM-T 35W /942

Lysytelse under oppstart

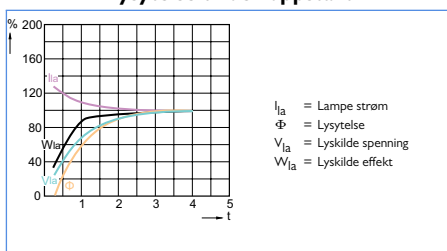

Lysytelse ved spenningsvariasjoner

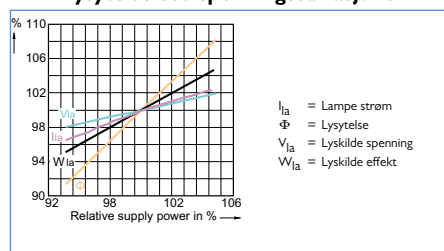

MASTERColour CDM-T 70W 150W 250W /942

Lysytelse under oppstart

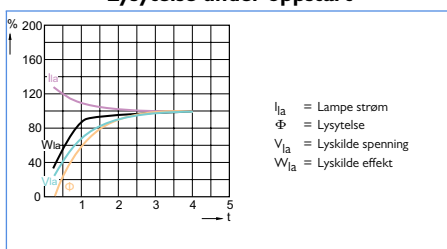

Lysytelse ved spenningsvariasjoner

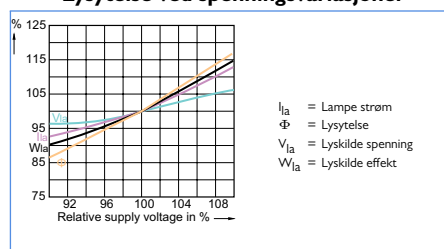

MASTERColour CDM
MASTERColour CDM-T

Energifordeling

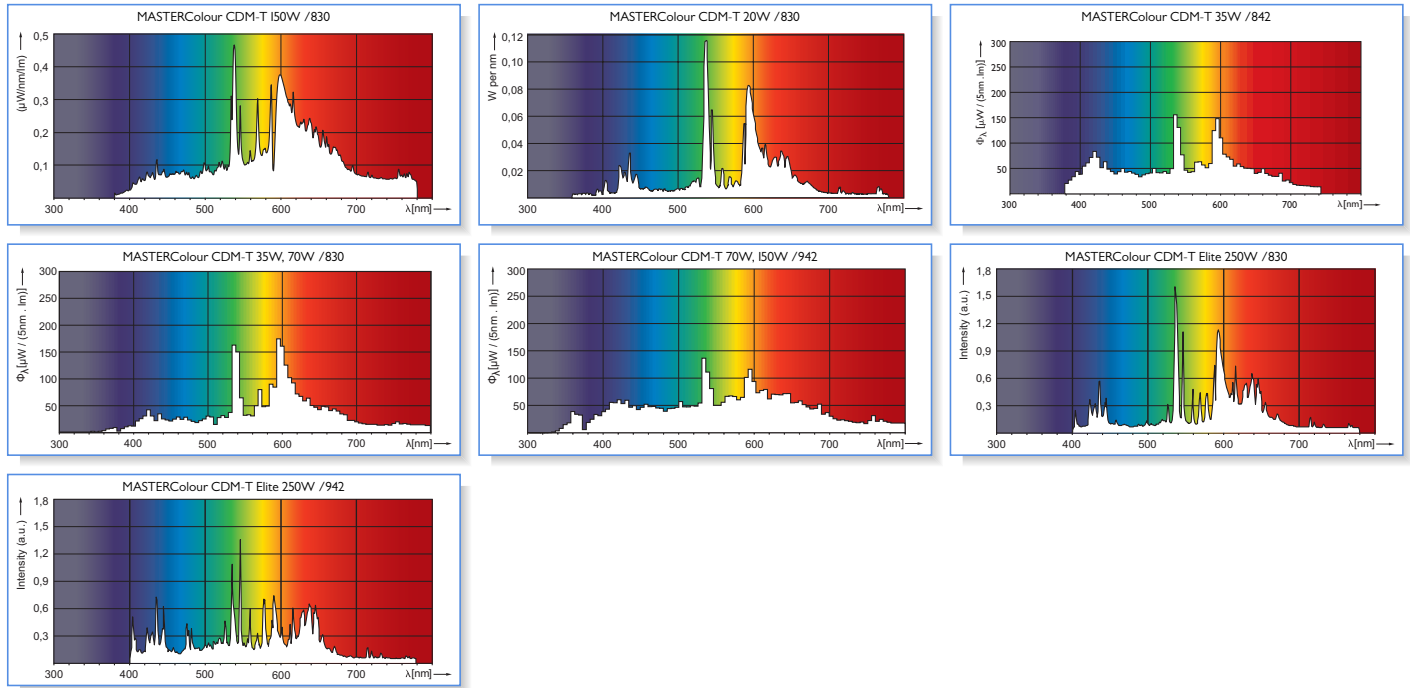

Polar diagram

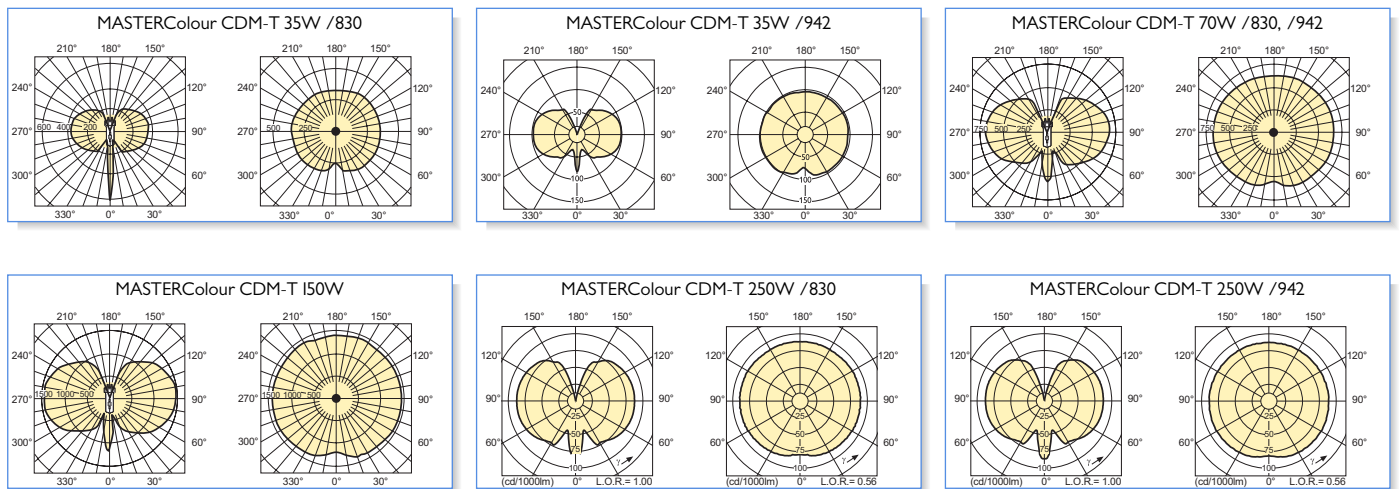

Polar light distribution

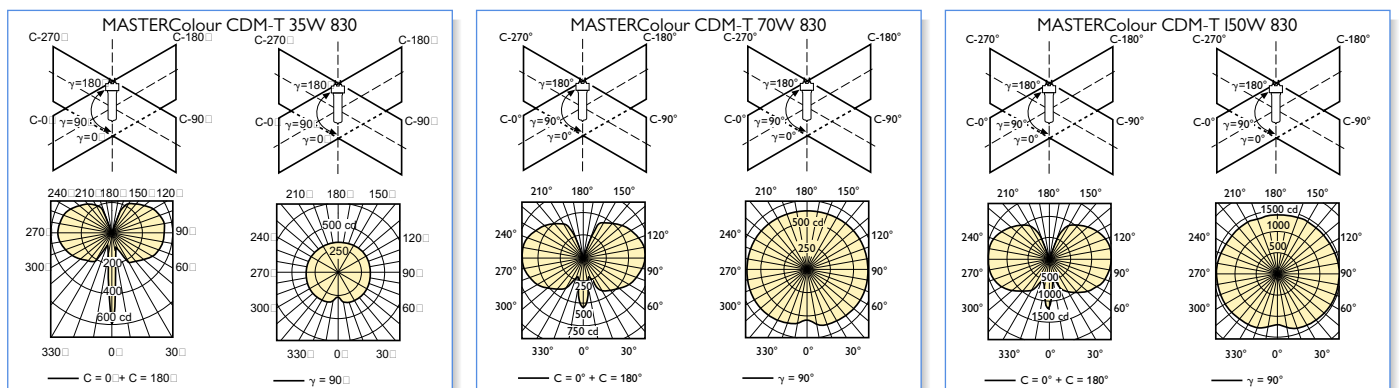

MASTERColour CDM
MASTERColour CDM-T

CRV diagrammer

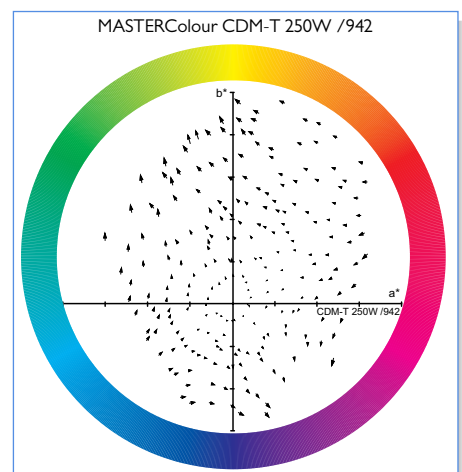
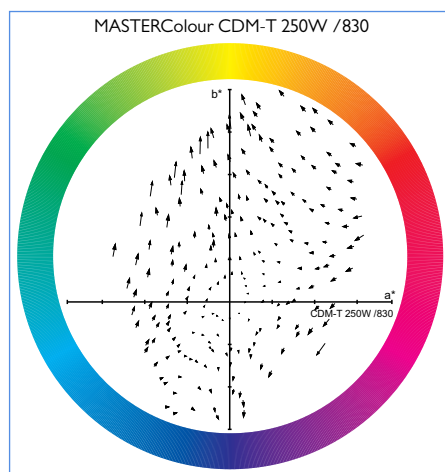
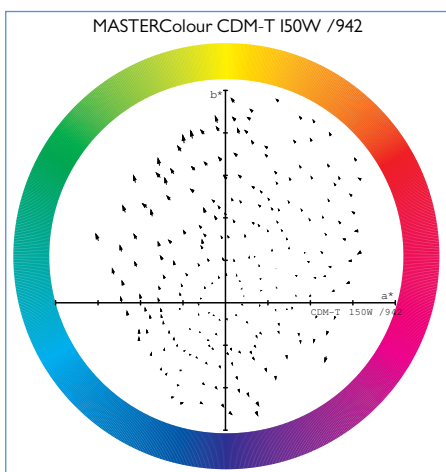
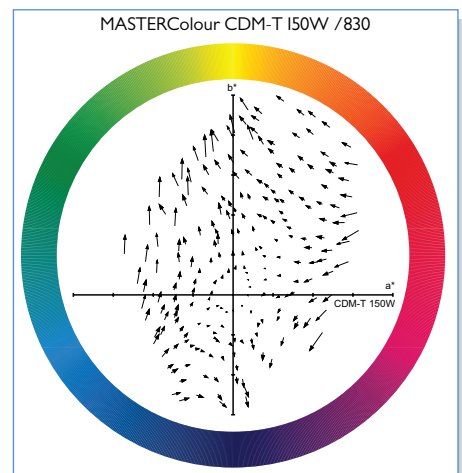
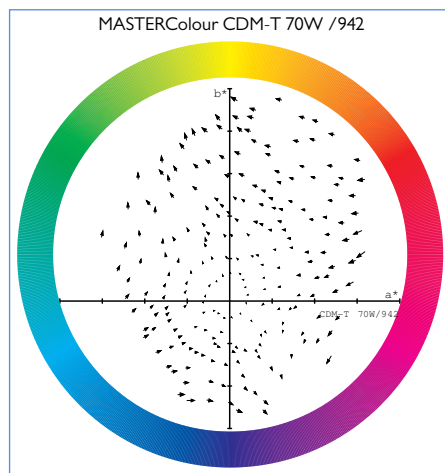
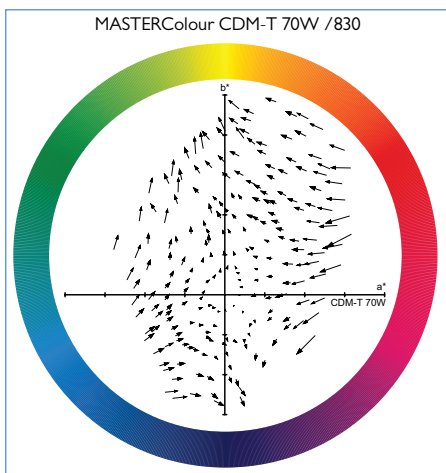
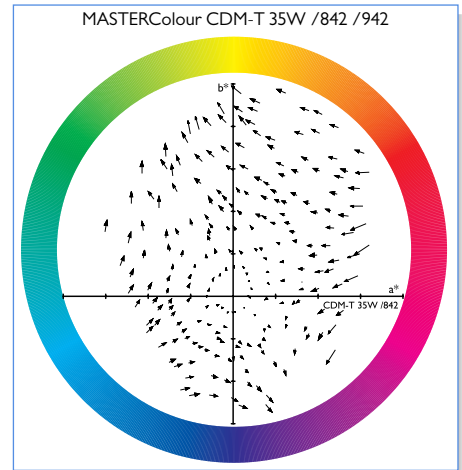
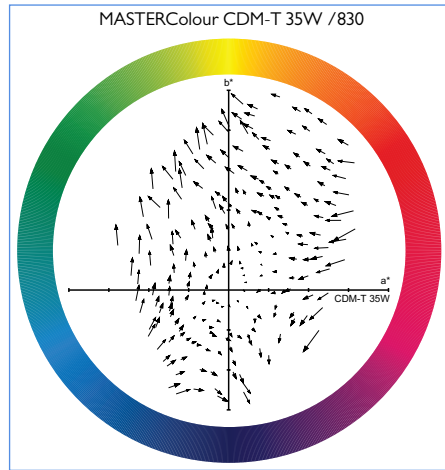
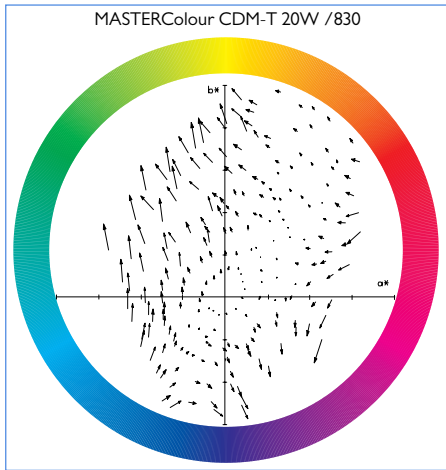

Sokkel

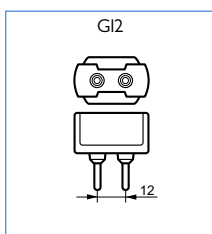

MASTERColour CDM
MASTERColour CDM-T

Additional extended technical data

Produktnavn	Spenningsstopp ved start	Start tid	Lampens lysutbytte EM	Fargebenevnelse
	(V [max.])	(sec. [max.])	(lm/W)	
MASTERColour CDM-T 20W/830 G12	-	30	-	Varmhvit
MASTERColour CDM-T 35W/830 G12	5000	30	79	Varmhvit
MASTERColour CDM-T 35W/842 G12	5000	30	-	Kaldhvit
MASTERColour CDM-T 70W/830 G12	5000	30	88	Varmhvit
MASTERColour CDM-T 70W/942 G12	5000	30	86	Kaldhvit
MASTERColour CDM-T 150W/830 G12	5000	30	90	Varmhvit
MASTERColour CDM-T 150W/942 G12	5000	30	83	Kaldhvit
MASTERColour CDM-T 250W/830 G12	5000	30	111	Varmhvit
MASTERColour CDM-T 250W/942 G12	5000	30	105	Kaldhvit

Produktnavn	Farge koordinat X	Farge koordinat Y	Lampekolbe utførelse	Lampekolbe	Lampens lysutbytte EL	Kvikksølv (Hg) innhold
					(lm/W)	(mg)
MASTERColour CDM-T 20W/830 G12	0.434	0.391	Klar	T19	90	3.50
MASTERColour CDM-T 35W/830 G12	0.428	0.397	Klar	T19	81	3.10
MASTERColour CDM-T 35W/842 G12	0.370	0.367	Klar	T19	79	2.70
MASTERColour CDM-T 70W/830 G12	0.432	0.395	Klar	T19	89	4.50
MASTERColour CDM-T 70W/942 G12	0.377	0.376	Klar	T19	86	6.10
MASTERColour CDM-T 150W/830 G12	0.436	0.396	Klar	T19	91	14.25
MASTERColour CDM-T 150W/942 G12	0.375	0.363	Klar	T19	85	10.40
MASTERColour CDM-T 250W/830 G12	0.435	0.393	Klar	T25	-	27.00
MASTERColour CDM-T 250W/942 G12	0.376	0.368	Klar	T25	-	19.00

Brennstilling



Luminance distribution

