

Warranty coupon

(Filled by seller)

Heating cable **CTACE-20, CTACE-30** (cross out unnecessary)

Length of heating cablem; Power.....

Selling date(year).....(month).....(day)

Salesman:.....
(name, surname, signature, seal)

(Filled by buyer)
(filled during installation)

Resistance of heating cable..... Ω (before installation)

Resistance of insulation of heating cable..... M Ω (before installation)

Resistance of heating cable..... Ω (after installation)

Resistance of insulation of heating cable..... M Ω (after installation)

**Comfort
Heat**
www.comforheat.eu



INSTALLATION INSTRUCTION OF HEATING CABLES

CTACE-20, CTACE-30

Comfort Heat UAB
Tel.: + 370 5 2704596
Fax.: + 370 5 2704498
Mobile.: + 370 68679670
Laisvės pr. 123
LT- 06118 Vilnius,
Lithuania
info@comforheat.eu
www.comforheat.eu

**Comfort
Heat**

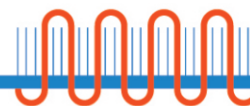

Electric heating cables **CTACE-20**, 20w/m and **CTACE-30**, 30w/m are suitable for frost protection of roof and gutter systems (gutters and downpipes) and ice and snow melting on ground areas (ramps, driveways, entrances to car parking, pavements, car parkings, bridges, stairs, etc.) or for ground thawing in winter time (i.e. in construction sites).

CTACE-20, 20 W/m and **CTACE-30** are twin conductor heating cables with 30 W/m output, double protection, aluminium tape and tinned cooper screen.

Technical data:

Voltage	230 V and 400 V
Type	CTACE-20; CTACE-30
Max output	20W/m; 30W/m.
Diameter of heating cable	6,2 mm
Conductor insulation	Fluoropolymer (FEP)
Overjacket	Polypropylene (XLPE)
Protection screen	Tinned cooper wires with diameter 1mm ² + 0,3 mm aluminium foil (AIPEL)
Overjacket of heating cable	Polypropylene (XLPE)
Power cord	5 m
Max temperature	+90°C
Min laying temperature	+5°C
Ambient temperature	-10...+90°C
Min bending radius of heating cable	No less than 5 diametes of cable
Protection class	IP67, UV resistant
Resistance	M2, C class
Applied standards	IEC 60800, CE, GOST R

Attention!!!

1. Every heating cable should be used according to the producer's recommendations. It should be correctly connected to the thermostat.
2. The heating cable should be connected to the power supply.
3. The installation of heating system should be done only by approved electrician in accordance with local Wiring Regulations.
4. The protection screen must be connected to the green-yellow earth wire.

I. FROST PROTECTION OF ROOF DOWNPIPES AND GUTTERS

The cable **CTACE-30** is suitable for roof frost protection and ice and snow melting system and can be used for frost and ice protection of downpipes and gutters and against icicles. The heating cable **CTACE-30** is led back and forth along the length of the gutter in one or two loops as required depending upon the diameter of the gutter (Ø 200 mm and more – two cable loops). In the gutter the heating cable is fixed using fixing clips. In the downpipe a metal chain is hung inside downpipe to which the fixing clips are attached (picture 1). The length of the heating cable is chosen according to the length of gutters and downpipes depending how many loops of heating cable will be installed in the gutter: one or two. The heating cable **CTACE-30** is produced in fixed lengths, so, if there is no required length of the cable, the heating system is designed by using several shorter heating cables and connecting them in the junction box.



X. WARRANTY

Warranty period for heating cables is **10 years**. Warranty is valid if following documents are presented:

1. Warranty coupon (filled correctly);
2. Document of purchase: invoice or receipt;
3. The obligation of **Comfort Heat** will be to repair or supply a new unit, free of charge to the customer, without secondary charges linked to repairing the unit.

The **Comfort Heat** warranty does not cover installation made by unauthorised electricians, or faults caused by incorrect designs supplied by others, misuse, damage caused by others, or incorrect installation or any subsequent damage that may occur. If **Comfort Heat** is required to inspect or repair any defects caused by any of the above, then all work will be fully chargeable.

The **Comfort Heat** warranty is void, if payment of the equipment is in default.

XI. CABLE LAYOUT SCHEME

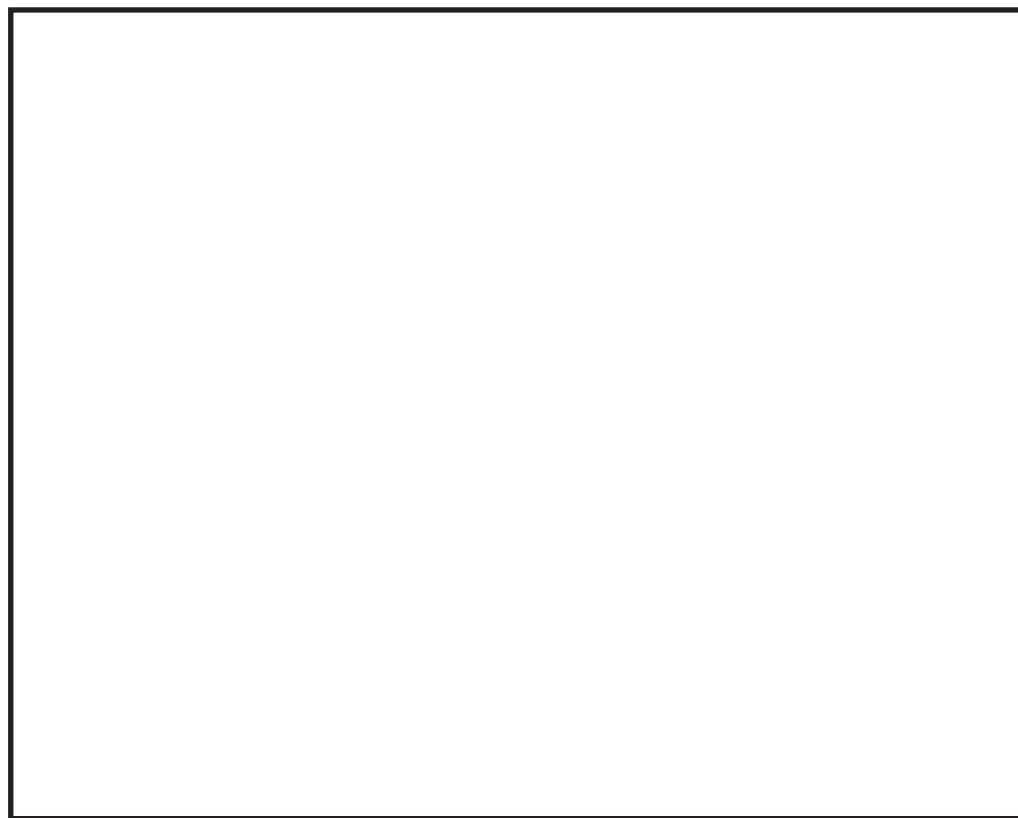

- Check if the product in the package corresponds to one indicated on the package label.
- Measure the resistance of heating cable and its insulation (the resistance of the cable has to correspond to the value indicated on the label +/- 5%). The value of insulation resistance has to be not less than 1MΩ.
- Before pouring the concrete measure the resistance of heating cable and its insulation. They should correspond to the same values measured before starting the work.
- Make photo or draw the layout of the installed heating cables.
- Pour the liquid concrete. The concrete should completely envelope the cables and seals so that there are no air pockets around them. Besides, the concrete mixture should not contain sharp stones as these could damage the cable.
- After finishing the concrete work, measure the resistance. The values should not differ.
- Allow the concrete to harden for 30 days and only then you can switch on the heating.

ATTENTION!!! The heating cable cannot be shortened, crossed or touch itself. In case of the cable damage the repair work should be done only by approved electrician. The cable is repaired by connecting it with the help of a special repairing kit.

VIII. HOW TO CHOOSE CONTROL FOR ICE AND SNOW MELTING SYSTEMS

A microprocessor thermostat **ETO2-4550** with LCD screen or electronic thermostat **ETR2-1550** together with the ground sensor **ETOG-55** should be used for effective ice protection control system.

The thermostat should be mounted in panel together with safety devices. When the capacity of heating system exceeds the capacity of thermostat, the contactor should be used. The ground **ETOR-55** should be installed in concrete or on tile surface (picture 5).

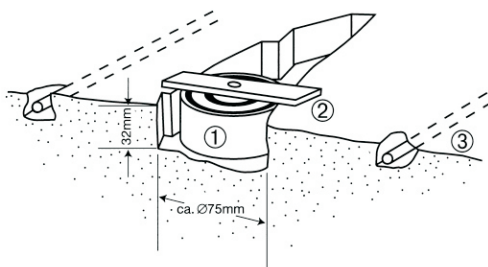

- 1 - Ground sensor **ETOG-55**
- 2 - Fixing clip
- 3 - Heating cable **CTACE-30**

ATTENTION!!! The heating cable cannot be shortened, crossed or touch itself. In case of the cable damage the repair work should be done only by approved electrician. The cable is repaired by connecting it with the help of a special repairing kit.



Pic. 1.

- 1- Gutter
- 2- Heating cable **CTACE-30**
- 3- Roof gutter clip
- 4- Downpipe
- 5- Stainless steel chain holder
- 6- Stainless steel chain
- 7- Fixing bracket for fixing the cable to the chain in the downpipe

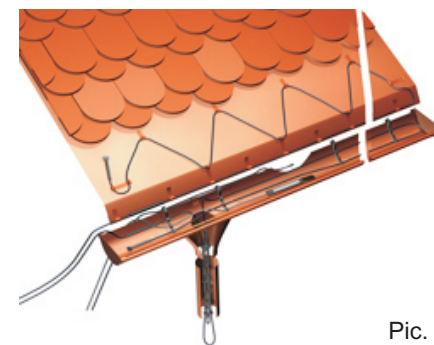

Pic. 2.

- 1- Roof edge
- 2- Heating cable **CTACE-30**
- 3- Fixing bracket **FB/GT**
- 4- Gutter
- 5- Cable fixing clip for downpipe
- 6- Downpipe
- 7- Stainless steel chain and chain holder
- 8- Fixing bracket for fixing the cable to the chain in the downpipe
- 9- Sensor **ETOR-55**

For the roofs with low slope (17°) the ice and snow melting system should be installed along the roof edge to prevent ice and snow formations along the edge of a cold roof. When the heating cable **CTACE-30** is used for roof edge heating, the distance between the loops should be no more than 10cm (picture 2).

II. HOW TO CHOOSE THE CONTROL FOR GUTTER AND DOWNPIPE HEATING SYSTEM

In order to have the efficiently working heating system, a programmed microprocessor based thermostat **ETO2-4550** with LCD screen or electronic thermostat **ETR2-1550**, together with the humidity sensor **ETOR-55** and ambient temperature sensor **ETF-744/99**, should be used. The thermostat should be mounted in panel together with safety devices. When the capacity of heating system exceeds the capacity of thermostat, the contactor should be used additionally. The humidity sensor **ETOR-55** should be installed in the gutter (picture 2). The ambient temperature sensor **ETF-744/99** should be installed on the northern part of the building or on the wall in the shadow.

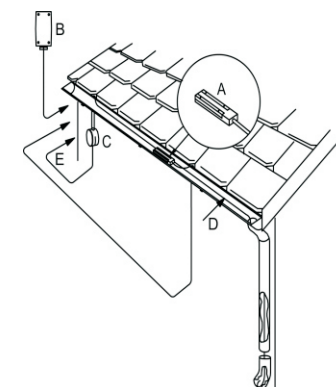

III. INSTALLATION OF ICE PROTECTION SYSTEM

In order to avoid injuries, accidents and to ensure a safe traffic, ice and snow melting systems can be installed in driveways, car parkings, entrances to car parkings, pavements, outdoor steps, loading ramps, observing platforms and bridges.

When choosing a necessary installation output (W/m²) for ice protection, the attention should be paid to several principal issues:

- The place where the system will be installed: geographical location and particularity.
- The customer's requirements for the system. The recommended output for ice protection system (car parkings, driveways, pavements, isolated steps, ramps and bridges) should be **250-350 W/m²**.
- The ice protection system installed in bridges or loading ramps is affected by cold air from above and below. In order to decrease the heat losses, it is advisable to lay a thermoinsulation layer under the cables. If the thermoinsulation is not possible, the recommended output should be **300 -400 W/m²**.

The ice protection system ensures safe entrance to garages, underground or multi-storey car parking areas or other steep slopes.

There are two ways of installing this system in the driveways:

- 1) Installing the heating in the whole area;
- 2) Installing the heating for tracks.

The first way (installation of heating in the whole area) is recommended for places with heavy traffic, so that a continuous and rapid traffic was ensured, and snow formations prevented on driveways. The second way (installation of heating for tracks) is more suitable for individual customers. When installing the heating cables on steep slopes it is necessary to provide a heated drain chute for the melted water at the bottom of the slope.

IV. HOW TO CHOOSE THE HEATING CABLE

When installing the ice protection system, the heating cable should be selected according to the area of heated surface and the necessary output (W/m²) (Table 1). For installation in larger areas several heating cables should be installed.

Voltage (V)	Length (m)	Output (W)	Driveways, parking pavements, entrances stairs (300 W/m ²)	Loading ramps, bridges (350 W/m ²)
			Area (m ²)	Area (m ²)
230	10	300	1	0,85
230	16	500	1,8	1,5
230	26	760	2,5	2,1
230	30	880	3	2,5
230	38	1150	4	3,3
230	49	1500	5	4,3
230	54	1620	5,5	4,7
230	68	2100	7	6
230	94	3000	10	8,6
230	150	4500	15	13

After choosing an appropriate length cable it is very important to choose the right distance between the cable loops C-C. **Example.** The C-C distance is calculated:

$$C-C = \frac{\text{Heated area (m}^2\text{)}}{\text{Length of heating cable (m)}} \times 100; \quad \text{Ex.: } C-C = \frac{3\text{m}^2}{30\text{m}} \times 100 = 10,00 \text{ (cm).}$$



V. INSTALLATION OF HEATING CABLE UNDER CONCRETE TILES

- Thoroughly clean the surface on which the heating cable will be laid.
- The heating cable should be laid on a smooth, free of sharp objects surface, covered with stone dust, sand or on a concrete base.
- Fix the installation tape on the prepared base.
- Check if the product in the package corresponds to one indicated on the package label.
- Measure the resistance of heating cable and its insulation (the resistance of the cable has to correspond to the value indicated on the label +/- 5%). The value of insulation resistance has to be not less than 1MΩ).
- Lay the heating cable and fix it on the installation tape keeping the distance C-C between the loops.
- It is very important to avoid the mechanical damage of the heating cable when the tiles are laid. For this reason cover the cable with the layer of stone dust or sand (2-3 cm) and lay the tiles (picture 3).

ATTENTION!!! The heating cable cannot be shortened, crossed or touch itself. In case of the cable damage the repair work should be done only by approved electrician. The cable is repaired by connecting it with the help of a special repairing kit.

- Before covering the heating cable with stone dust measure the resistance of heating cable and its insulation, they should correspond to the same values measured before starting the work.
- Make photo or draw the layout of the installed heating cables.
- After laying the tiles, measure the resistance. The values should not differ.

VI. INSTALLATION OF HEATING CABLE UNDER CONCRETE

- Before covering the heating cable with stone dust measure the resistance of heating cable and its insulation, they should correspond to the same values measured before starting the work.
- Make photo or draw the layout of the installed heating cables.
- After laying the tiles, measure the resistance. The values should not differ.

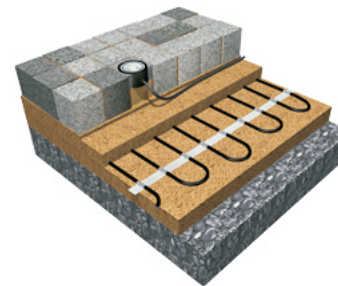

Pic. 3

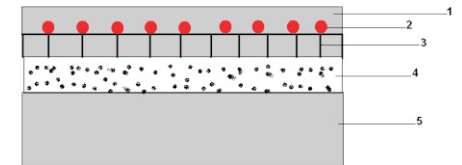

Pic. 4

- 1- Ground
- 2- The base of stone dust, sand or concrete
- 3- Heating cable **CTACE-30**
- 4- Stone dust or sand layer
- 5- Ground sensor ETOG-55
- 6- Tiles

- 1- Concrete
- 2- Heating cable **CTACE-30**
- 3- Metal armouring
- 4- Thermoinsulation layer
- 5- Concrete or solid base

