

FEATURES

- 4 different sharp beam angles
- Wide variety of TM30 optimized LEDs
- ENEC approved drivers
- IEEE P1789 Flickerfree driver to 1%

SPRINGS

Standard with CS springs (concrete/gyproc).
On request also available as above with
WS springs (gypro/metal).



LV 18° / 37° / 60°



LV 80° (on request)

COLOURS

Available colours:



Nr	Housing	Inside ring
	RAL 9016	
XX=61	Matt white	Gold
XX=63	Matt white	Silver
XX=62	Matt white	Black
XX=65	Matt white	White



Nr	Housing	Inside ring
	RAL 9005	
XX=71	Matt black	Gold
XX=74	Matt black	Silver
XX=72	Matt black	Black
XX=76	Matt black	White

Strada 100 LV

Fixed

SPECIFICATIONS

Beam angle (FWHM)	18° / 37° / 60° (80° on request)
Fixture material	Die cast aluminium
Environment	Indoor
IP rate	IP20 / IP44
IK rate	IK09
Operating temperature (Ta)	-20°C / +45°C ¹
Safety marks	EN60598 / EN62031 / EN62471
EMC compliance	EN55015
Colour consistency (SDCM)	MacAdam step 3
Warranty	7 years * (within the European Union and the countries of the Free Trade Association for products delivered after 1 May 2015)
Energy class	These products contains a light source of energy efficiency class F (CRI97 3000K) / D (CRI80 3000K/4000K)

This luminaire contains built-in LED lamps. The lamps cannot be changed in the luminaire. EU 874/2012

¹ In applications with a flat roof (f.i. car showrooms) the temperatures may exceed 45°C. Please ask our sales office for a special driver.



Ask our sales department about the possibilities for:
- Tunable white 2700-6500K.
- Extra LED options from the LUXEON Stylist Series

Only when the product is installed in a closed ceiling it may be exposed to water splashes, and only on its front side.

IP20

IP44

STRADA 100 VARIATIONS

Strada 100	CRI80	3000/4000K	3000/3400Lm	incl. power supply	page 3
Strada 100	CRI80	3000/4000K	5000/5700Lm	incl. power supply	page 4
Strada 100	CRI97	3000K	2500Lm	incl. power supply	page 5
Strada 100	CRI97	3000K	3750Lm	incl. power supply	page 6

CRI80/97 CHOOSE YOUR LV LUMEN OUTPUT

	mA	W	Lumen Output			Lumen / Watt			Driver types				
			CRI80	CRI80	CRI97	CRI80	CRI80	CRI97	No dim	Triac	1-10V&Push	Dali	Casambi
			3000K	4000K	3000K	3000K	4000K	3000K					
Special request	250	9,4	1200	1400	800	127	149	85	127570	x	126421	127576	x
Special request	350	13,2	1650	1900	1100	125	144	83	127570	x	127021	127576	127630
Special request	500	17,9	2250	2500	1450	125	139	81	127570	127032	127021	127576	127630
Standard	700	27,0	3000	3400	2150	111	126	80	127484N	122260	127021	127576	127630
Special request	800	32,1	3400	3750	2500	106	117	78	127484N	on request	127021	127490	127630
Special request	900	35,5	3700	4100	2700	104	115	76	127484N	on request	127021	127490	127630
Special request	1050	41,7	4200	4700	3000	101	113	72	127484N	on request	127021	127490	127630
Standard	1200	50,5	5000	5700	3250	99	113	64	127690	on request	123170	123170	On request
Special request	1400	57,2	5600	6300	3750	98	110	66	127310	on request	123170	123170	On request

DIMENSIONS

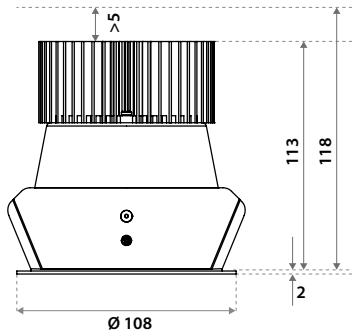

HOLE SIZE



Using CS springs: $\varnothing 100$ mm. Thickness ceiling 5-118 mm & recess depth 118 mm. For plasterboard ceilings or similar harder materials thicker than 9 mm.



Using WS springs: $\varnothing 100$ mm. Thickness 1-55 mm & recess depth 118 mm. For soft ceiling tiles. We recommend using a ceiling ring on the reverse side of the tile.

STRADA 100 LV
CRI80 3000/3400LM
ITEM SPECIFICATIONS (PART A)

Description	18°		37°		60°		Type	mA	Vf
	Item code	UGR	Item code	UGR	Item code	UGR			
Strada 100 LV 3000 Lm 3000K CRI80 No dim	852003XXCA02	18.8	852003XXCB02	18.3	852003XXCC02	21.3	Incl. PSU	700	35,3
Strada 100 LV 3000 Lm 3000K CRI80 1-10V & Push	852003XXNA02	18.8	852003XXNB02	18.3	852003XXNC02	21.3	Incl. PSU	700	35,3
Strada 100 LV 3000 Lm 3000K CRI80 Dali	852003XXPA02	18.8	852003XXPB02	18.3	852003XXPC02	21.3	Incl. PSU	700	35,3
Strada 100 LV 3400 Lm 4000K CRI80 No dim	852003XXCD02	19.2	852003XXCE02	18.7	852003XXCF02	21.7	Incl. PSU	700	35,3
Strada 100 LV 3400 Lm 4000K CRI80 1-10V & Push	852003XXND02	19.2	852003XXNE02	18.7	852003XXNF02	21.7	Incl. PSU	700	35,3
Strada 100 LV 3400 Lm 4000K CRI80 Dali	852003XXPD02	19.2	852003XXPE02	18.7	852003XXPF02	21.7	Incl. PSU	700	35,3

ITEM SPECIFICATIONS (PART B)

Description	W	Lm	Lm/W	CRI (typ.)	Pf	Ripple	Inrush current	B-16A Fuse	Safety class	Energy class
Strada 100 LV 3000 Lm 3000K CRI80 No dim	27,0	3000	111	82	0.95	<3%	5A 50µS	50 pcs	I	D
Strada 100 LV 3000 Lm 3000K CRI80 1-10V & Push	27,0	3000	111	82	0.95	<3%	5A 50µS	50 pcs	II	D
Strada 100 LV 3000 Lm 3000K CRI80 Dali	27,0	3000	111	82	0.95	<3%	5A 50µS	50 pcs	II	D
Strada 100 LV 3400 Lm 4000K CRI80 No dim	27,0	3400	126	82	0.95	<3%	5A 50µS	50 pcs	I	D
Strada 100 LV 3400 Lm 4000K CRI80 1-10V & Push	27,0	3400	126	82	0.95	<3%	5A 50µS	50 pcs	II	D
Strada 100 LV 3400 Lm 4000K CRI80 Dali	27,0	3400	126	82	0.95	<3%	5A 50µS	50 pcs	II	D

ITEM SPECIFICATIONS (PART C)

Description	Weight	Dimensions single carton	Quantity per carton	Expected lifespan B10 reported (25°C)		
				L70B10	L80B10	L90B10
Strada 100 LV CRI80	850 gr	190x150x120 mm	32 pcs	>60.500 hrs	>60.500 hrs	>60.500 hrs

All values are measured at 230V (+/- 7%)

STRADA 100 LV
CRI80 5000/5700LM
ITEM SPECIFICATIONS (PART A)

Description	18°		37°		60°		Type	mA	Vf
	Item code	UGR	Item code	UGR	Item code	UGR			
Strada 100 LV 5000 Lm 3000K CRI80 No dim	852003XXCR02	20.5	852003XXCS02	20.0	852003XXCT02	23.1	Incl. PSU	1200	37,5
Strada 100 LV 5000 Lm 3000K CRI80 1-10V & Push	852003XXNK02	20.5	852003XXNL02	20.0	852003XXNM02	23.1	Incl. PSU	1200	37,5
Strada 100 LV 5000 Lm 3000K CRI80 Dali	852003XXPK02	20.5	852003XXPL02	20.0	852003XXPM02	23.1	Incl. PSU	1200	37,5
Strada 100 LV 5700 Lm 4000K CRI80 No dim	852003XXCU02	21.0	852003XXCV02	20.5	852003XXCW02	23.5	Incl. PSU	1200	37,5
Strada 100 LV 5700 Lm 4000K CRI80 1-10V & Push	852003XXNN02	21.0	852003XXNP02	20.5	852003XXNQ02	23.5	Incl. PSU	1200	37,5
Strada 100 LV 5700 Lm 4000K CRI80 Dali	852003XXPN02	21.0	852003XXPP02	20.5	852003XXPQ02	23.5	Incl. PSU	1200	37,5

ITEM SPECIFICATIONS (PART B)

Description	W	Lm	Lm/W	CRI (typ.)	Pf	Ripple	Inrush current	B-16A Fuse	Safety class	Energy class
Strada 100 LV 5000 Lm 3000K CRI80 No dim	50,5	5000	99	82	0.95	<3%	10A 200µS	30 pcs	II	D
Strada 100 LV 5000 Lm 3000K CRI80 1-10V & Push	50,5	5000	99	82	0.95	<3%	10A 200µS	30 pcs	I	D
Strada 100 LV 5000 Lm 3000K CRI80 Dali	50,5	5000	99	82	0.95	<3%	10A 200µS	30 pcs	I	D
Strada 100 LV 5700 Lm 4000K CRI80 No dim	50,5	5700	113	82	0.95	<3%	10A 200µS	30 pcs	II	D
Strada 100 LV 5700 Lm 4000K CRI80 1-10V & Push	50,5	5700	113	82	0.95	<3%	10A 200µS	30 pcs	I	D
Strada 100 LV 5700 Lm 4000K CRI80 Dali	50,5	5700	113	82	0.95	<3%	10A 200µS	30 pcs	I	D

ITEM SPECIFICATIONS (PART C)

Description	Weight	Dimensions single carton	Quantity per carton	Expected lifespan B10 reported (25°C)		
				L70B10	L80B10	L90B10
Strada 100 LV CRI80	850 gr	190x150x120 mm	32 pcs	>60.500 hrs	>60.500 hrs	>60.500 hrs

All values are measured at 230V (+/- 7%)

STRADA 100 LV

CRI97 2500LM

ITEM SPECIFICATIONS (PART A)

Description	18°		37°		60°		Type	mA	Vf
	Item code	UGR	Item code	UGR	Item code	UGR			
Strada 100 LV 2500 Lm 3000K CRI97 No dim	852003XXCG02	18.1	852003XXCH02	17.6	852003XXCJ02	20.6	Incl. PSU	800	35,3
Strada 100 LV 2500 Lm 3000K CRI97 1-10V & Push	852003XXNG02	18.1	852003XXNH02	17.6	852003XXNJ02	20.6	Incl. PSU	800	35,3
Strada 100 LV 2500 Lm 3000K CRI97 Dali	852003XXPG02	18.1	852003XXPH02	17.6	852003XXPJ02	20.6	Incl. PSU	800	35,3

ITEM SPECIFICATIONS (PART B)

Description	W	Lm	Lm/W	CRI (typ.)	Pf	Ripple	Inrush current	B-16A Fuse	Safety class	Energy class
Strada 100 LV 2500 Lm 3000K CRI97 No dim	32,1	2500	78	97	0.95	<3%	5A 50µS	50 pcs	I	F
Strada 100 LV 2500 Lm 3000K CRI97 1-10V & Push	32,1	2500	78	97	0.95	<3%	5A 50µS	50 pcs	II	F
Strada 100 LV 2500 Lm 3000K CRI97 Dali	32,1	2500	78	97	0.95	<3%	5A 50µS	50 pcs	II	F

ITEM SPECIFICATIONS (PART C)

Description	Weight	Dimensions single carton	Quantity per carton	Expected lifespan B10 reported (25°C)		
				L70B10	L80B10	L90B10
Strada 100 LV 2500 Lm 3000K CRI97	850 gr	190x150x120 mm	32 pcs	>60.500 hrs	>60.500 hrs	>60.500 hrs

All values are measured at 230V (+/- 7%)

STRADA 100 LV

CRI97 3750LM

ITEM SPECIFICATIONS (PART A)

Description	18°		37°		60°		Type	mA	Vf
	Item code	UGR	Item code	UGR	Item code	UGR			
Strada 100 LV 3750 Lm 3000K CRI97 No dim	852003XXFD02	19.5	852003XXFE02	19.0	852003XXFF02	22.1	Incl. PSU	1400	37,5
Strada 100 LV 3750 Lm 3000K CRI97 1-10V & Push	852003XXNR02	19.5	852003XXNS02	19.0	852003XXNT02	22.1	Incl. PSU	1400	37,5
Strada 100 LV 3750 Lm 3000K CRI97 Dali	852003XXPR02	19.5	852003XXPS02	19.0	852003XXPT02	22.1	Incl. PSU	1400	37,5

ITEM SPECIFICATIONS (PART B)

Description	W	Lm	Lm/W	CRI (typ.)	Pf	Ripple	Inrush current	B-16A Fuse	Safety class	Energy class
Strada 100 LV 3750 Lm 3000K CRI97 No dim	57,2	3750	66	97	0.95	<3%	10A 200µS	30 pcs	II	F
Strada 100 LV 3750 Lm 3000K CRI97 1-10V & Push	57,2	3750	66	97	0.95	<3%	10A 200µS	30 pcs	I	F
Strada 100 LV 3750 Lm 3000K CRI97 Dali	57,2	3750	66	97	0.95	<3%	10A 200µS	30 pcs	I	F

ITEM SPECIFICATIONS (PART C)

Description	Weight	Dimensions single carton	Quantity per carton	Expected lifespan B10 reported (25°C)		
				L70B10	L80B10	L90B10
Strada 100 LV 3750 Lm 3000K CRI97	850 gr	190x150x120 mm	32 pcs	>60.500 hrs	>60.500 hrs	>60.500 hrs

All values are measured at 230V (+/- 7%)

NEW STANDARDS REQUIRE NEW LEDS

TM-30 (new color norm): The Illuminating Engineering Society (IES) has published a new Technical Memorandum – TM-30-15 entitled “IES Method for Evaluating Light Source Color Rendition” – that promises to supplant CRI as a color metric. TM-30 relies on separate fidelity and gamut metrics, as well as a set of color samples that is more representative of real-world objects, as opposed to the pastel samples that were primarily used for the baseline CRI metric that was sometimes called Ra. The new color metric is intended to fairly and accurately characterize both LED-based solid-state lighting (SSL) and legacy sources.



Desaturated

CRI = 80 / R_g = 92



Red-Enhanced

CRI = 98 / R_g = 103

SPECIAL LEDS AVAILABLE

	CCT	CRI	R9	RF	RG	R15	TLCI	DOWNLIGHTS SMALL		DOWNLIGHTS LARGE		DOWNLIGHTS LARGE		ITEM CODE
								MA	LM	MA	LM	MA	LM	
CRI80	2700K	82	5	82	92	75	69	350 mA	1550	700 mA	2900	1200 mA	4800	51-4028-27-1
CRI80	3000K	82	5	81	93	75	66	350 mA	1625	700 mA	3000	1200 mA	5000	51-4028-30-1
CRI80	4000K	82	5	81	93	74	66	350 mA	1700	700 mA	3400	1200 mA	5700	51-4028-40-1
CRI97	2700K	97	93	96	103	99	97	350 mA	1150	800 mA	x	1400 mA	x	50-3031-27
CRI97	3000K	97	96	95	103	100	97	350 mA	1250	800 mA	2500	1400 mA	3750	50-3031-30
CRI97	4000K	97	96	95	103	100	97	350 mA	1350	800 mA	x	1400 mA	x	50-3031-40
CrispWhite	3000K	90	61	87	102	89	83	350 mA	780	900 mA	2300	1400 mA	3550	51-4029-30
CrispColor	4000K	95	96	90	101	95	96	350 mA	1050	900 mA	2700	1400 mA	4700	51-4051-40
Red Meat	1800K	82	81	77	119	95	60	350 mA	515	900 mA	1750	1400 mA	2350	51-4042-00
Bread & Pastries	2700K	92	54	89	96	86	91	350 mA	770	900 mA	2600	1400 mA	3500	51-4045-00

2700K

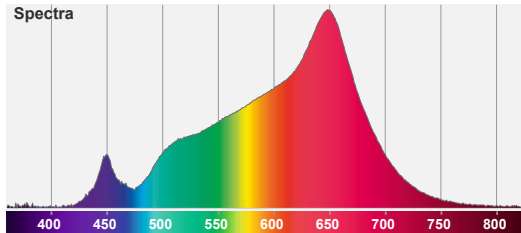
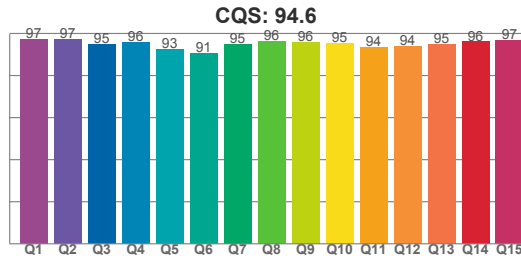
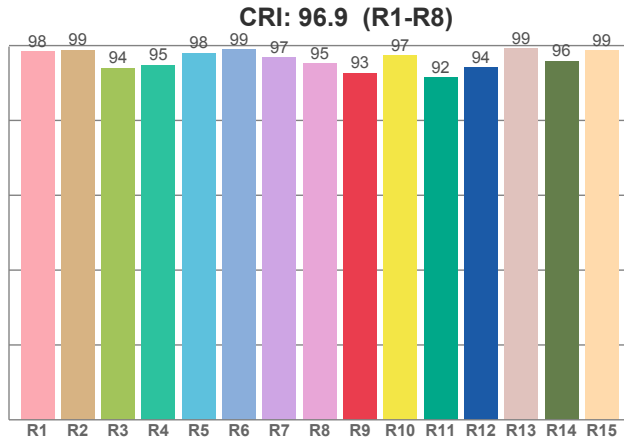

CCT	CRI	CRI R9	TM30 Rf	TM30 Rg	CQS
2700K	96.9	92.7	96.0	102.6	94.6

3000K

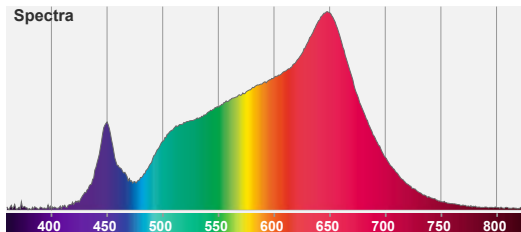
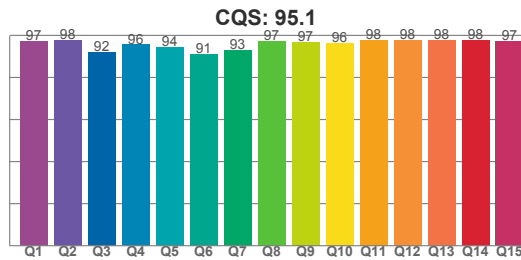
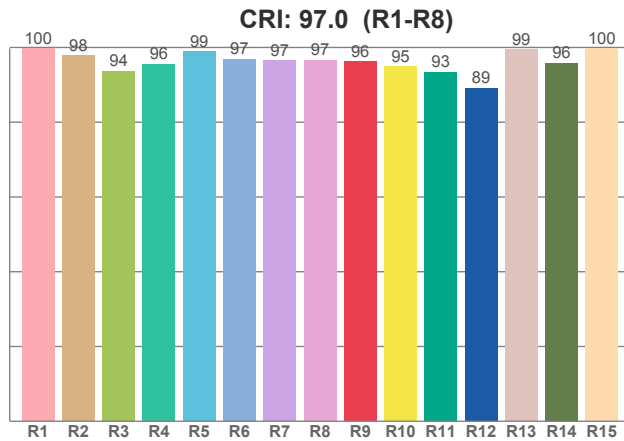

CCT	CRI	CRI R9	TM30 Rf	TM30 Rg	CQS
3000 K	97.0	96.2	95.0	103.3	95.1

4000K

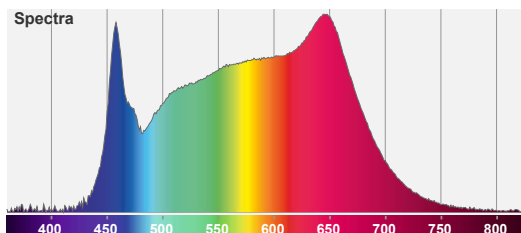
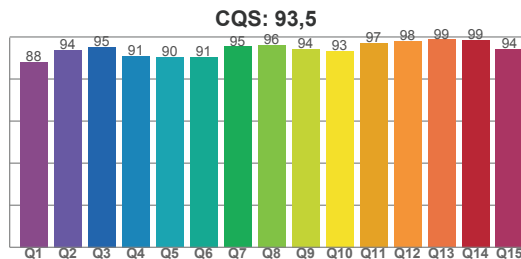
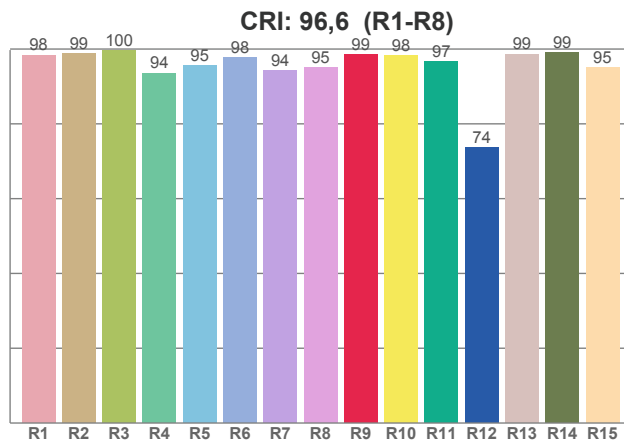

CCT	CRI	CRI R9	TM30 Rf	TM30 Rg	CQS
4000K	96.6	98.5	88.3	96.2	93.5